

CMS-2803

Microwave Mixer Diode

Description:

Calmos CMS-2803 Schottky diode was designed applications ranging from 10-14 GHz. They are optimized for use at X/Ku bands and are ideal for downconverter applications. It is available in plastic SOT-23 standard package configurations.

At Calmos Technology, our commitment to quality components gives our customers a reliable source of RF products. Manufacturing techniques assure that when two diodes are mounted into a single package they are taken from adjacent sites on the wafer. The various package configurations available provide a low cost solution to a wide variety of design problems.

Features:

- **Low Capacitance 0.20pF**
- **Low Conversion Loss**
- **Low RD**
- **Optimized for applications ranging 10-14 GHz**
- **Low Cost SM Plastic Package**

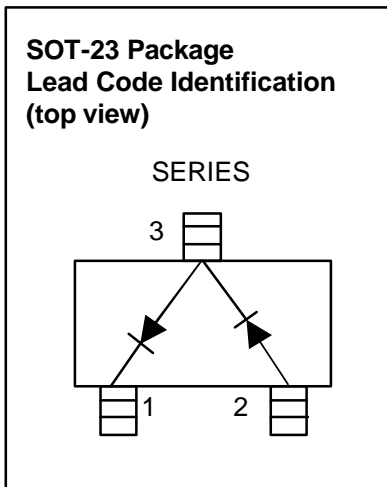

Pin Connections and Package Marking

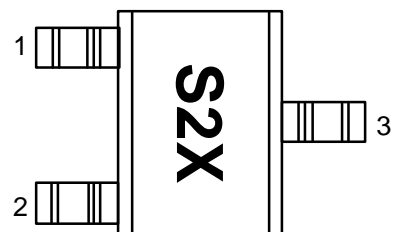

Notes:

1. Package marking provides orientation and identification
2. See "Electrical Specifications" for appropriate package marking

Electrical Specifications, $T_C = +25^\circ\text{C}$, Single Diode

Part Number CMS-	Package Marking Code	Configuration	Forward Voltage V_F (mV)		Typical Capacitance C_T (pF)
			250 Min	350 Max	
2803	S3Z	Series Pair	250 Min	350 Max	0.20
Test Conditions			$I_F = 0.75 \text{ mA}$		$V_R = 0 \text{ V}$, $f = 1 \text{ MHz}$

Typical Parameters, Single Diode

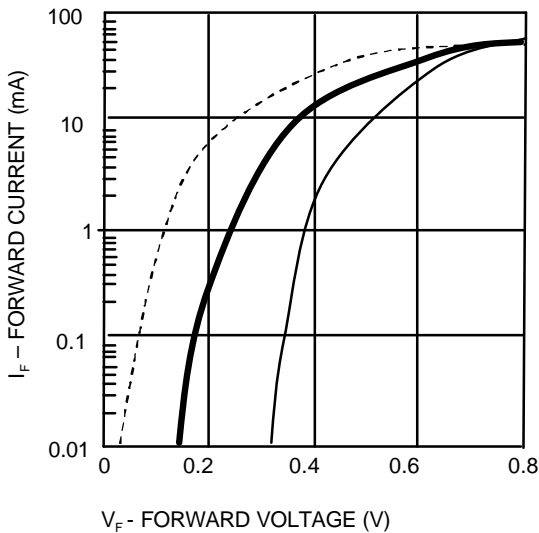

Graph 1: Typical Forward Current vs. Forward Voltage at Three Temperatures

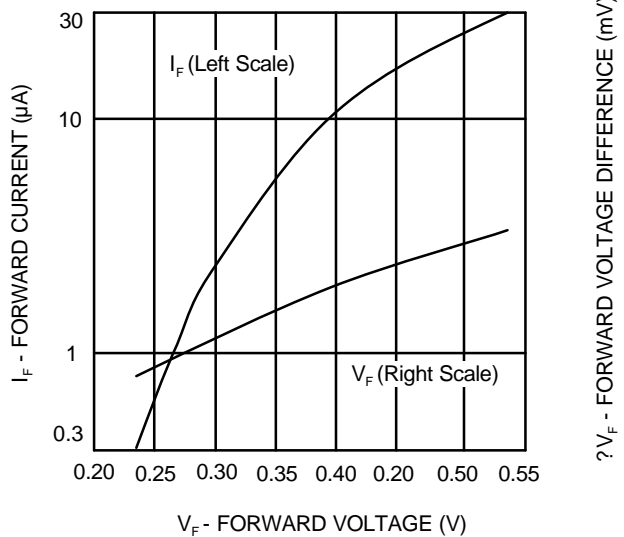

Graph 2: Typical VF Match.

Absolute Maximum Ratings, Measured at = +25°C

Symbol	Parameter	Unit	Min	Max
P_{IV}	Peak Inverse Voltage	V	—	4
T_J	Junction Temperature	°C	—	+150
T_{STG}	Storage Temperature	°C	-65	+150
T_{OP}	Operating Temperature	°C	-65	+150
P_T	Total Device Dissipation	mW	—	75

RF Electrical Parameters, Measured at = +25°C

Symbol	Parameter	Units	Typical
L_C	Conversion Loss at 12 GHz	dB	6.3
Z_{IF}	IF Impedance	Ω	150
SWR	SWR at 12 GHz		1.2

Equivalent Linear Circuit Model

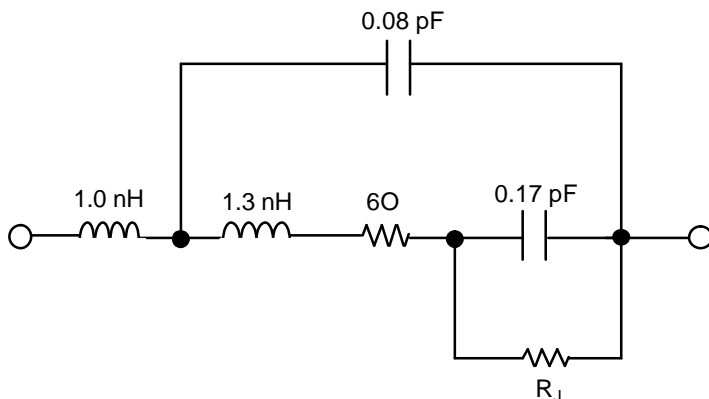

* R_J @1mA = 263 and @2.5mA = 142

Package Dimensions

Outline 23 (SOT-23)

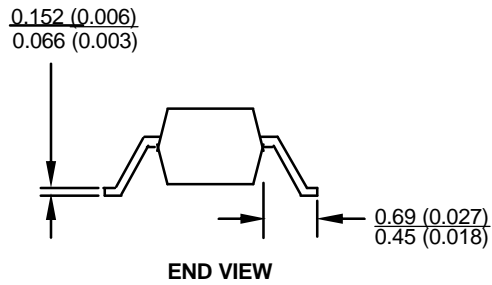
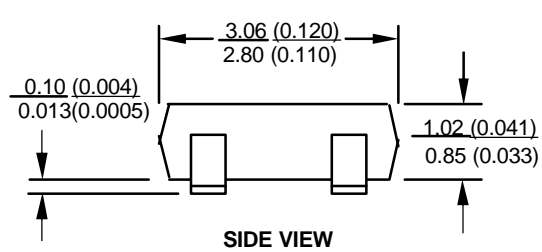
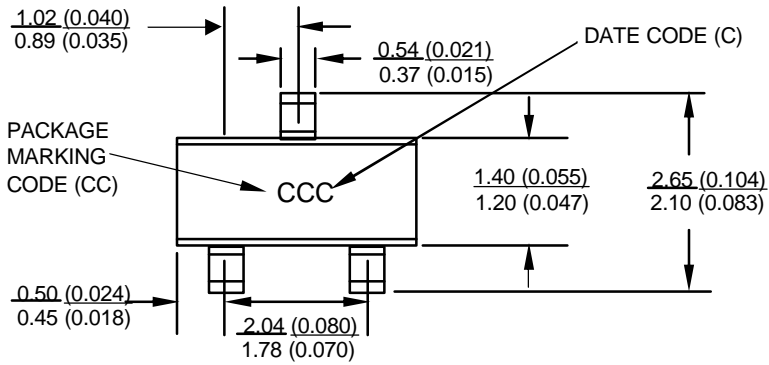

DIMENSIONS ARE IN MILLIMETERS (INCHES)

Cross Reference Guide

CALMOS PART NUMBER	AGILENT PART NUMBER
CMS2803	HSMS8202

Part Number Ordering Information

PART NUMBER	NO. OF DEVICES	CONTAINER
CMS-2803-TR2	10,000	13" Reel
CMS-2803-TR1	2500	7" Reel
CMS-2803-BLK	100	Antistatic bag

www.calmotech.com

Revised 07/14/04

Data subject to change

Copyright © 2004 Calmos Technology Inc.